

Short Specification:

The LED Conversion Kit is one of our most versatile LED products. It was designed by two electricians who wanted to make a labor and energy saving LED retrofit kit for common gas canopy fixtures. The standard LED conversion board is designed to retrofit 95% of these fixtures currently installed in the field; fuel station canopies, building wall packs, low bays, shoe boxes, and cobra head street lights. With the use of our standard adjustable light brackets, or a custom-designed adapter plate, it makes the conversion user-friendly and very quick. There are multiple upgrades available for this retrofit kit as well, which are designed for the gas station canopy market. These conversion kits provide a sleek and modern look—a huge update from bulky, outdated eyesores. Whether you want to swap out the “guts” of the fixture or give your fixture an entirely new look, the RC line will get the job done at a low cost while saving energy.



| MODEL | DESCRIPTION | WATTS | RATED LUMENS | COLOR TEMP |
|----------------|---|-------|--------------|------------|
| RC-30-CNP-LED | RC-30 LED Conversion Kit | 30 | 3,780 | 5,000K |
| RC-52-CNP-LED | RC-52 LED Conversion Kit | 60 | 7,560 | 5,000K |
| RC-52-ID-LED | RC-52 LED Conversion Kit (Interior Use) | 60 | 7,560 | 5,000K |
| RC-90-CNP-LED | RC-90 LED Conversion Kit | 90 | 11,220 | 5,000K |
| RC-120-CNP-LED | RC-120 LED Conversion Kit | 120 | 14,850 | 5,000K |
| RC-150-CNP-LED | RC-150 LED Conversion Kit | 150 | 18,522 | 5,000K |

For a complete list of approved fixtures and values, please visit DLC QPL at www.designlights.org/QPL



Application:

- Building Wall Pack Retrofit
- Cobra Head Lighting Retrofit
- Gas Station Canopy Retrofit
- Low Bay Lighting Retrofit
- Shoebox/Parking Lot Lighting

Features:

- DLC listed
- UL recognized (E471619) luminaire conversion retrofit kit for permanently connected HID.
- Minimum 50,000 hour chip life at 55 °C constant temperature under IESNA test conditions
- 1/8" 6061 US aluminum heat sink with emissive coating for maximum heat dissipation
- Philips Luxeon H.L. LEDs
- 3 driver options available: Philips Advance Driver (120/277V) Meanwell Driver (120/240V) OSRAM Driver (120/277V) For RC-90, RC-120 and RC-150 only.
- CRI: 80
- 5 year limited warranty



Made in the U.S.A.



Driver Specifications:

Philips Advance Driver: 120/277V

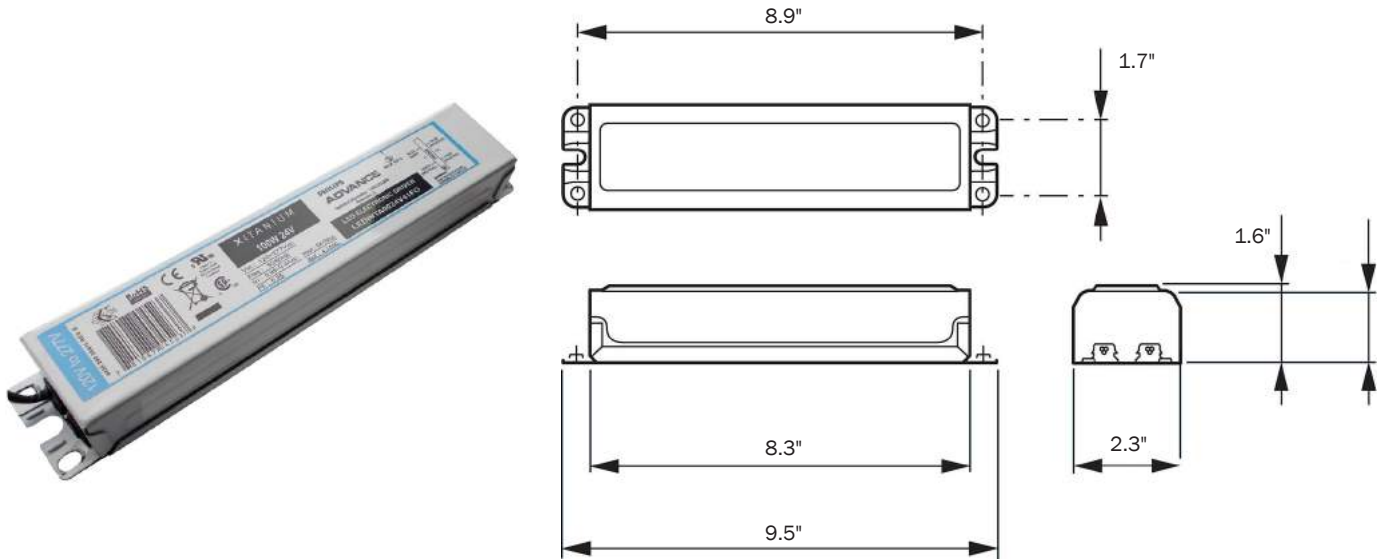

Meanwell Driver: 120/240V

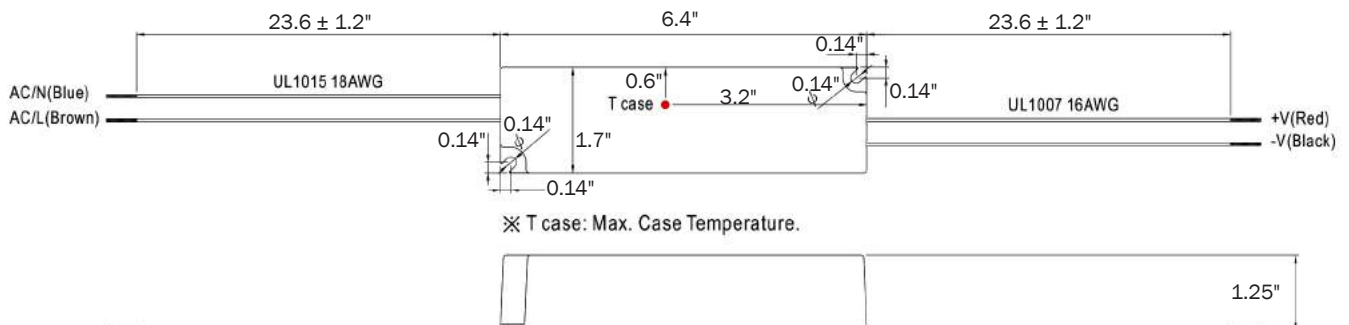

Driver Specifications:

OSRAM Driver: 120/277V (Only for RC-90,RC-120 and RC-150)

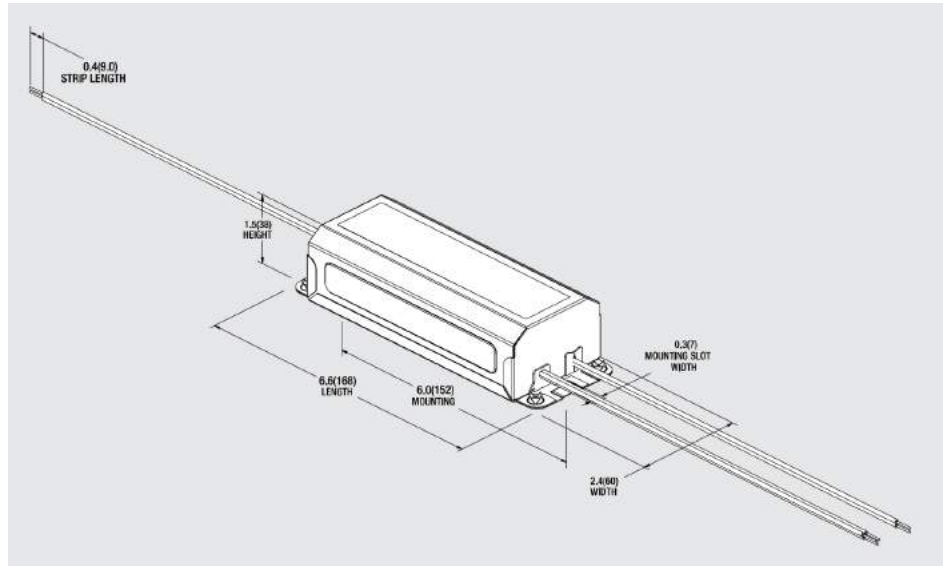

Comparisons:

Example 1: Canopy Retrofit From a Distance

BEFORE: 455W Metal Halide



AFTER: RC-52-CNP LED (at 60W each)



Example 2: Pole Mounted Area Light Retrofit (RC - LAP)

BEFORE: 1080W Metal Halide



AFTER: (2) RC-52-CNP LED (at 60W each) - 120W



Physical Dimensions:



Standard RC-52-CNP-LED

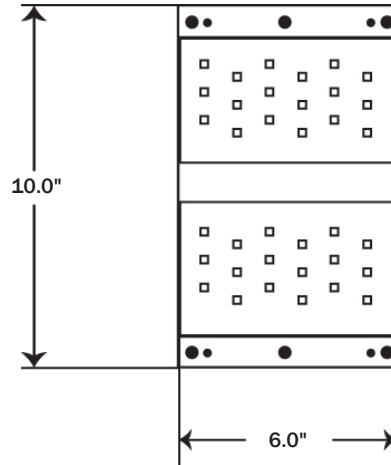

Standard RC-30-CNP-LED

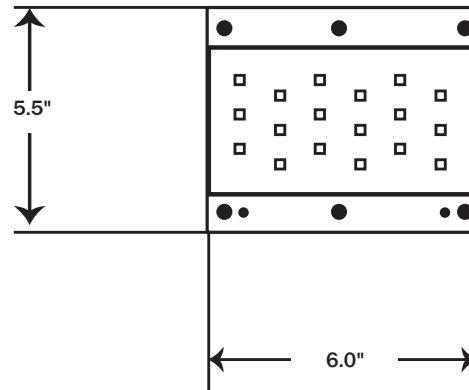

Upgrades:

- **RC-SAS: Slide Adapter Set (2)** - Adjustable brackets which provide the LED conversion plate with a proper mounting height inside the fixture.
- **RC-MBA: Mogul Base Adapter** - Allows mounting to a mogul base parallel with bottom of fixture.
- **RC-MBA-90: 90° Mogul Base Adapter** - Allows mounting to a mogul base perpendicular with bottom of fixture. Includes sleeve and bracket.
- **RC-LAP: All Area Adapter Light Panels** - Designed based on the current reflector installed in the original fixture. We then build a custom metal bracket that fits perfectly into the fixture being retrofitted.
- **RC-SLPAK: Scottsdale™* Low-Profile Adapter Kit** - This kit replaces the old glass drop lens with a sleek, low profile lens. The LED Conversion Kit is installed in the lens and then fully enclosed. There are only 2 parts with this kit, the driver and the lens with the LEDs mounted within.
- ***-480V-277V Step Down Transformer (Requires 277V Driver)** - Required when supply voltage is 480V.

* Scottsdale™ is a registered trademark of LSI Corp.

Upgrade Details:

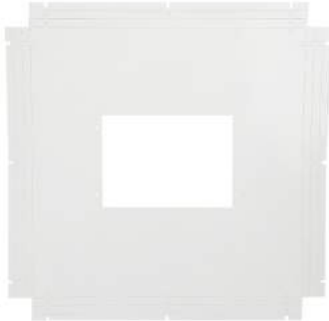

RC-LAP-XX
(RC-LAP-20 pictured)



RC-SAS: Slide Adapter Set



RC-MBA: Mogul Base Adapter
(Pictured with RC-52)



RC-MBA-90: 90° Mogul Base Adapter



Scottsdale™* Low-Profile Adapter Kit

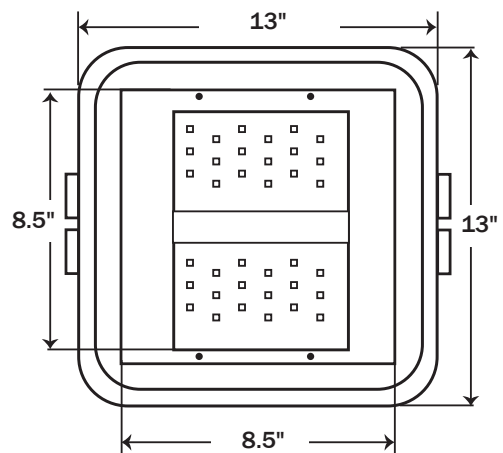

Scottsdale™* Low-Profile Adapter is approx. 1" deep